

Minuto

INSTRUCTIONS FOR USE

Type HD8763

Read carefully before using the machine.



EN

02

CE

Register your product and get support at
www.philips.com/welcome

IMPORTANT SAFEGUARDS

When using electrical appliances, basic safety precautions should always be followed, including the following:

1. Read all instructions.
2. Do not touch hot surfaces. Use handles or knobs.
3. To protect against fire, electric shock and injury to persons do not immerse cord, plugs, or appliance in water or other liquid.
4. Close supervision is necessary when the appliance is used by or near children.
5. Unplug from outlet when not in use and before cleaning. Allow to cool before putting on or taking off parts, and before cleaning the appliance.
6. Do not operate any appliance with a damaged cord or plug or after the appliance malfunctions, or has been damaged in any manner. Return appliance to the nearest authorized service facility for examination, repair or adjustment.
7. The use of accessory attachments not recommended by the appliance manufacturer may result in fire, electric shock or injury to persons.
8. Do not use outdoors.
9. Do not let cord hang over edge of table or counter, or touch hot surfaces.
10. Do not place on or near a hot gas or electric burner, or in a heated oven.
11. Always attach plug to appliance first, then plug cord into wall outlet. To disconnect, turn any control to "off", then remove plug from wall outlet.
12. Do not use appliance for other than intended use.
13. Save these instructions.

SAVE THESE INSTRUCTIONS

CAUTION

This appliance is for household use only. Any servicing, other than cleaning and user maintenance, should be performed by an authorized service center. Do not immerse machine in water. To reduce the risk of fire or electric shock, do not disassemble the machine. There are no parts inside the machine serviceable by the user. Repair should be done by authorized service personnel only.

1. Check voltage to be sure that the voltage indicated on the nameplate corresponds with your voltage.
2. Never use warm or hot water to fill the water tank. Use cold water only.
3. Keep your hands and the cord away from hot parts of the appliance during operation.
4. Never clean with scrubbing powders or harsh cleaners. Simply use a soft cloth dampened with water.
5. For optimal taste of your coffee, use purified or bottled water. Periodic descaling is still recommended every 2-3 months.
6. Do not use caramelized or flavored coffee beans.

INSTRUCTIONS FOR THE POWER SUPPLY CORD

- A. A short power-supply cord (or detachable power-supply cord) is to be provided to reduce risks resulting from becoming entangled in or tripping over a longer cord.
- B. Longer detachable power-supply cords or extension cords are available and may be used if care is exercised in their use.
- C. If a long detachable power-supply cord or extension cord is used,
 1. The marked electrical rating of the detachable power-supply cord or extension cord should be at least as great as the electrical rating of the appliance
 2. If the appliance is of the grounded type, the extension cord should be a grounding-type 3-wire cord, and
 3. The longer cord should be arranged so that it will not drape over the counter top or table top where it can be pulled on by children or tripped over.

Congratulations on your purchase of a Saeco Minuto One Touch Cappuccino full automatic coffee machine!

To fully benefit from the support that Saeco offers, please register your product at www.philips.com/welcome.

This user manual applies to HD8763.

The machine is suitable for preparing espresso coffee using whole coffee beans, and it is supplied with a milk carafe so you can brew a perfect cappuccino in a quick and easy way.

In this user manual you will find all the information you need to install, use, clean and descale your machine.

CONTENTS

IMPORTANT	4
Safety Instructions	4
Warning	4
Caution	6
Compliance with Standards	7
INSTALLATION	8
Product Overview.....	8
General Description.....	9
PREPARING FOR USE	10
Machine Packaging	10
Machine Installation	10
USING THE MACHINE FOR THE FIRST TIME	12
Circuit Priming	12
Automatic Rinse/Self-Cleaning Cycle.....	13
Manual Rinse Cycle.....	14
Measuring and Programming Water Hardness.....	17
"INTENZA+" Water Filter Installation	18
Replacing the "INTENZA+" Water Filter	20
ADJUSTMENTS	21
Saeco Adapting System.....	21
Adjusting the Ceramic Coffee Grinder.....	21
Adjusting the Aroma (Coffee Strength)	22
Adjusting the Coffee Dispensing Spout	23
Adjusting the Coffee Length	24

ESPRESSO AND COFFEE BREWING	25
Espresso and Coffee Brewing Using Coffee Beans.....	25
Espresso and Coffee Brewing Using Pre-Ground Coffee	26
MILK CARAFE.....	27
Filling the Milk Carafe	27
Inserting the Milk Carafe.....	28
Removing the Milk Carafe	28
Emptying the Milk Carafe.....	29
CAPPUCCINO BREWING	30
Adjusting the Cappuccino Length.....	32
FROTHING MILK.....	33
Adjusting the Milk Froth Length	35
DISPENSING HOT WATER	36
CLEANING AND MAINTENANCE	38
Daily Cleaning of the Machine.....	38
Daily Cleaning of the Water Tank	39
Daily Cleaning of the Milk Carafe.....	40
Weekly Cleaning of the Machine	42
Weekly Cleaning of the Milk Carafe	43
Weekly Cleaning of the Brew Group.....	45
Monthly Cleaning of the Milk Carafe	48
Monthly Lubrication of the Brew Group	51
Monthly Cleaning of the Brew Group with "Coffee Oil Remover"	52
Monthly Cleaning of the Coffee Bean Hopper.....	55
DESCALING.....	56
PROGRAMMING.....	61
The following settings can be adjusted	61
How to Program the Machine	62
MEANING OF THE DISPLAY ICONS.....	64
TROUBLESHOOTING.....	68
ENERGY SAVING.....	70
Stand-by	70
Disposal	70
TECHNICAL SPECIFICATIONS.....	71
WARRANTY AND SERVICE	71
Warranty	71
Service	71
ORDERING MAINTENANCE PRODUCTS	72

IMPORTANT

Safety Instructions

This machine is equipped with safety features. Nevertheless read the safety instructions carefully and only use the machine as described in these instructions to avoid accidental injury or damage.

Keep this user manual for future reference.



The term **WARNING** and this icon warn against possible severe injuries, danger to life and/or damage to the machine.



The term **CAUTION** and this icon warn against slight injuries and/or damage to the machine.



This icon requests to read carefully this instruction manual, before performing any use or maintenance operation.

Warning

- Connect the machine to a wall socket with a voltage matching the technical specifications of the machine.
- Do not let the power cord hang over the edge of a table or counter, or touch hot surfaces.
- Never immerse the machine, mains plug or power cord in water (danger of electrical shock).
- Never direct the hot water jet towards body parts: danger of burns!
- Do not touch hot surfaces. Use handles and knobs.

- Remove the mains plug from the wall socket:
 - If a malfunction occurs.
 - If the machine will not be used for a long time.
 - Before cleaning the machine.

Pull on the plug, not on the power cord. Do not touch the mains plug with wet hands.
- Do not use the machine if the mains plug, the power cord or the machine itself is damaged.
- Do not make any modifications to the machine or its power cord. Only have repairs carried out by a service centre authorised by Philips to avoid a hazard.
- The machine should not be used by children younger than 8 years old.
- The machine can be used by children of 8 years and upwards if they have previously been instructed on the correct use of the machine and made aware of the associated dangers or if they are supervised by an adult.
- Cleaning and maintenance should not be carried out by children unless they are more than 8 years old and supervised by an adult.
- Keep the machine and its power cord out of reach of children under 8 years old.
- The machine may be used by persons with reduced physical, sensory or mental capabilities or lacking sufficient experience and/or skills if they have previously been instructed on the correct use of the machine and made aware of the associated dangers or if they are supervised by an adult.

- Children should be supervised to ensure that they do not play with the machine.
- Never insert fingers or other objects into the coffee grinder.

Caution

- The machine is for household use only and is not intended for use in environments such as canteens, staff kitchens of shops, offices, farms or other work environments.
- Always put the machine on a flat and stable surface.
- Do not place the machine on hot surfaces, directly next to a hot oven, heater or similar source of heat.
- Only put coffee beans into the coffee bean hopper. If ground coffee, instant coffee or any other substance is put in the coffee bean hopper, it may damage the machine.
- Let the machine cool down before inserting or removing any parts.
- Never use warm or hot water to fill the water tank. Use only cold non sparkling drinking water.
- Never clean with scrubbing powders or harsh cleaners. Simply use a soft cloth dampened with water.
- Descale your machine regularly. The machine indicates when descaling is needed. Not doing this will make your appliance stop working properly. In this case repair is not covered under your warranty!
- Do not keep the machine at temperature below 0 °C. Residue water in the heating system may freeze and cause damage.

- Do not leave water in the water tank when the machine is not used over a long period of time. The water can be contaminated. Use fresh water every time you use the machine.

Compliance with Standards

The machine complies with art.13 of the Italian Legislative Decree dated 25 July 2005, no. 151 "Implementation of the Directives 2005/95/EC, 2002/96/EC and 2003/108/EC on the restriction of the use of certain hazardous substances in electrical and electronic equipment, as well as waste disposal".

This machine complies with EU Directive 2002/96/EC.

This Philips appliance complies with all the applicable standards and regulations relating to the exposure to electromagnetic fields.

INSTALLATION

Product Overview

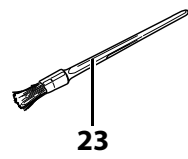
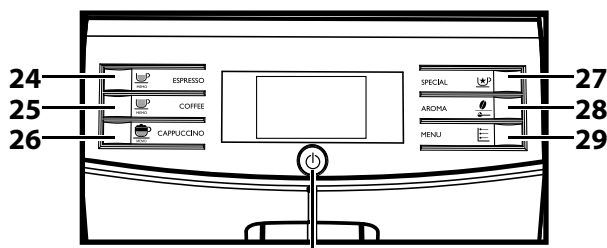
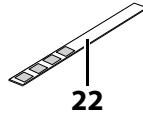
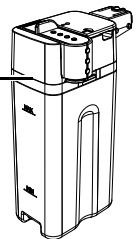
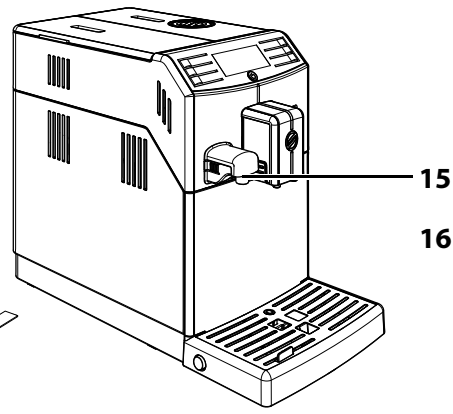
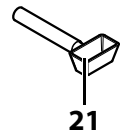
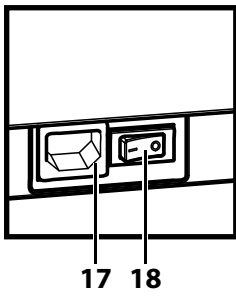
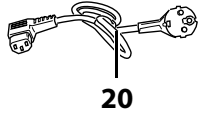
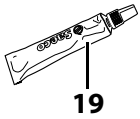
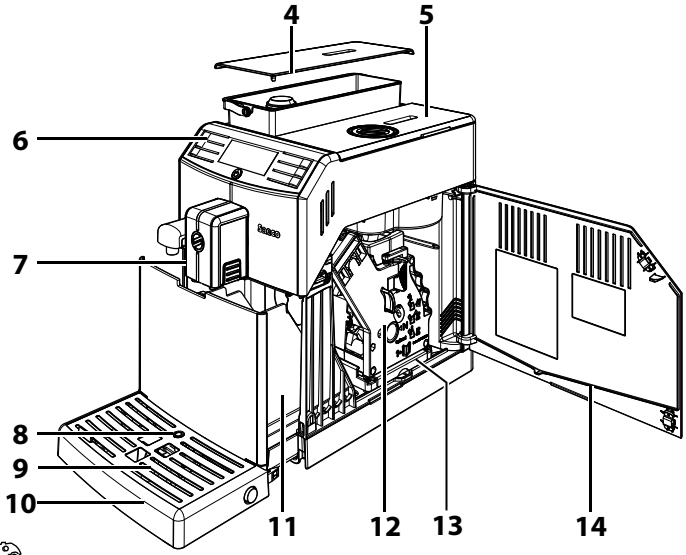
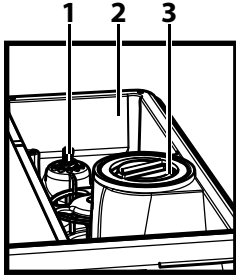

General Description

1. Grinder adjustment knob
2. Coffee bean hopper
3. Pre-ground coffee compartment
4. Water tank + Lid
5. Coffee bean hopper lid
6. Control panel
7. Coffee dispensing spout
8. Full drip tray indicator
9. Cup holder grill
10. Drip tray
11. Coffee grounds drawer
12. Brew group
13. Coffee residues drawer
14. Service door
15. Water dispensing spout (removable)
16. Milk carafe
17. Power cord socket
18. Power button
19. Grease for the brew group
20. Power cord
21. Coffee grinder adjustment key + Pre-ground coffee scoop
22. Water hardness test strip
23. Cleaning brush
24. Espresso brew button
25. Coffee brew button
26. Cappuccino brew button
27. Special products button
28. "Aroma" - Pre-ground coffee button
29. Menu button
30. ON/OFF button
31. Descaling solution- to be purchased separately

PREPARING FOR USE

Machine Packaging

The original packaging has been designed and constructed to protect the machine during transport. We recommend keeping the packaging material for possible future transport.

Machine Installation

1 Remove the machine from the packaging.

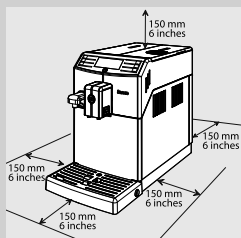

2 For best use, it is recommended to:

- Choose a safe, level surface, where there will be no danger of overturning the machine or being injured.
- Choose a location that is sufficiently well-lit, clean and near an easily reachable socket.
- Allow for a minimum distance from the sides of the machine as shown in the illustration.

3 Remove the water tank lid.

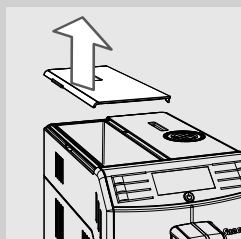

4 Lift the water tank using the handle.

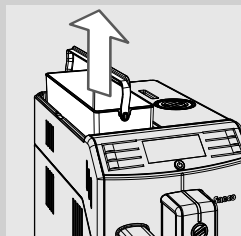

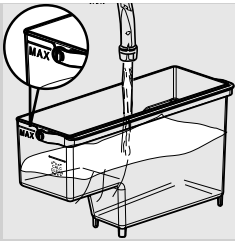

5 Rinse the water tank with fresh water.

6 Fill the water tank with fresh water up to the MAX level and reinsert it into the machine. Make sure it is fully inserted.



Caution:

Never fill the water tank with warm, hot, sparkling water or any other liquid, as this may cause damage to the water tank and the machine.

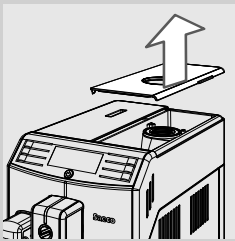

7 Remove the coffee bean hopper lid.

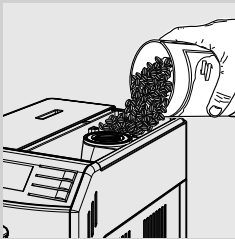

8 Slowly pour the coffee beans into the coffee bean hopper.



Note:

Do not pour too many coffee beans into the coffee bean hopper as this will reduce the grinding performance of the machine.



Caution:

Only coffee beans must be put into the coffee bean hopper. Ground coffee, instant coffee, caramelized coffee or any other object may damage the machine.

9 Put back the coffee bean hopper lid on the coffee bean hopper.

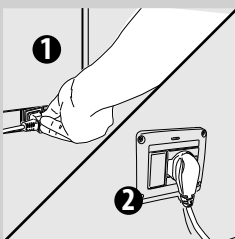

10 Insert the plug into the socket located on the back of the machine.

11 Insert the plug at the other end of the power cord into a wall socket with suitable power voltage.

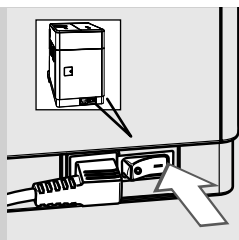

12 Switch the power button to "I" to turn on the machine. The "⏻" button flashes.

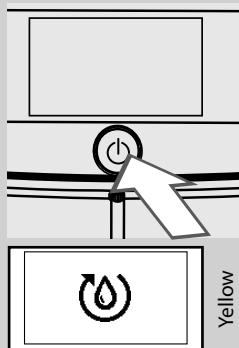

13 To turn on the machine simply press the "⏻" button. The machine automatically primes the circuit.

USING THE MACHINE FOR THE FIRST TIME

When using the machine for the first time, the following activities need to happen:

- 1) The machine will prime the circuit;
- 2) The machine will perform an automatic rinse/self-cleaning cycle.
- 3) You need to initiate a manual rinse cycle.

Circuit Priming

During this process fresh water flows through the internal circuit of the machine and the machine warms up. This takes a few minutes.

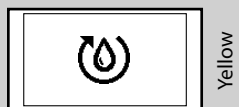

1 The machine automatically primes the circuit.



Yellow

- 2 The bar under the icon shows the operation progress. When the process is completed, the machine stops dispensing automatically.

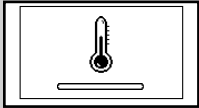

Yellow

- 3 Then the control panel shows the machine warm-up icon.

Automatic Rinse/Self-Cleaning Cycle

When warm-up is complete, the machine automatically performs a rinse/self-cleaning cycle of the internal circuit with fresh water. This takes less than a minute.



- 1 Place a container under the coffee dispensing spout to catch the small amount of water which will be dispensed.



Yellow

- 2 The machine shows this display. Wait for the cycle to finish automatically.



Note:

You can stop dispensing by pressing the "☕" button.



Green

- 3 When the above steps are complete, the machine shows this display. You can now perform the manual rinse cycle.

Manual Rinse Cycle

During this process you activate the coffee brewing cycle and fresh water flows through the water circuit. This takes a few minutes.



- 1 Place a container under the coffee dispensing spout.

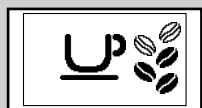

Green

- 2 Check that the machine shows this display.

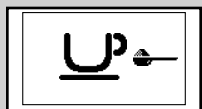

Green

- 3 Select the pre-ground coffee brewing function by pressing the "☕" button. The machine shows this display.



Note:

Do not add pre-ground coffee to the compartment.

- 4 Press the "☕" button. The machine will start dispensing water from the dispensing spout.
- 5 When the dispensing has finished, empty the container. Repeat the operations from step 1 to step 4 twice, then continue with step 6.

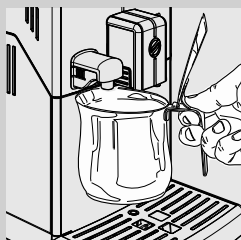

- 6 Place a container under the water dispensing spout.

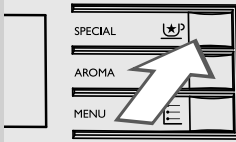

Green

7 Press the “☺” button. The machine shows this display.

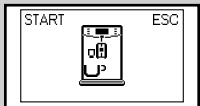
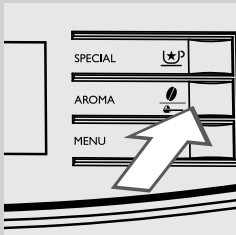

Green

8 Press the “☺” button to start dispensing hot water.

9 This icon is displayed. The machine reminds you to install the water dispensing spout. Check that the water dispensing spout is correctly installed. Press “☺” to confirm. The machine will start dispensing hot water.

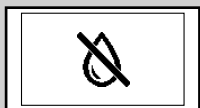

Red

10 Dispense water until the no water icon appears.



Note:

You can stop the manual rinsing by pressing the “☺” button.

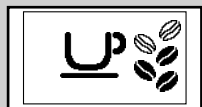
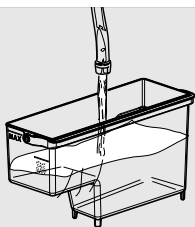

Green

- 11** At the end, fill the water tank again up to the MAX level. Now the machine is ready for coffee brewing. You will see this display.

 **Note:**

When you haven't used the machine for 2 or more weeks, the machine will automatically perform an automatic rinse/self-cleaning cycle after you switch it on. Thereafter you need to initiate the manual rinse cycle as described above.

The automatic rinse/self-cleaning cycle is also initiated when the machine has been in stand-by mode, or switched off, for more than 15 minutes. After this cycle has been completed, you can brew a coffee.

Measuring and Programming Water Hardness

Water hardness measuring is very important in order to define the descaling frequency and to install the "INTENZA+" water filter (for more detail on the water filter, see next chapter).

To measure the water hardness follow the steps below:

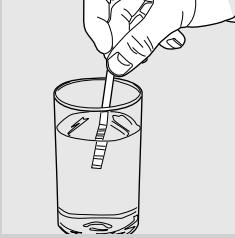

- 1** Immerse the water hardness test strip (supplied with the machine) in water for 1 second.



Note:

The test strip can only be used for one single measurement.

- 2** Wait for one minute.

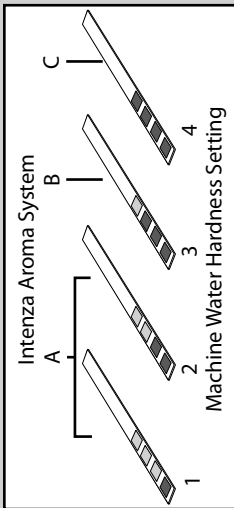

- 3** Check how many squares have changed the colour to red and then refer to the table.



Note:

The numbers on the water hardness test strip correspond to the water hardness adjustment settings.

More precisely:

- 1 = 1 (very soft water)
- 2 = 2 (soft water)
- 3 = 3 (hard water)
- 4 = 4 (very hard water)

The letters correspond to the references that are located at the base of the "INTENZA+" water filter (see next chapter).

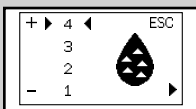

Yellow

- 4** Press the "≡" button and scroll the pages by pressing the "←" button until the following icon is displayed.



Note:

The machine is supplied with a standard water hardness setting, suitable for most types of water.

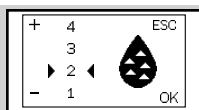

Yellow

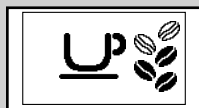

Green

5 Press the “☕” button to increase the value or the “☕” button to decrease the value.

6 Press the “☰” button to confirm the setting.

7 Press the “☕” button to exit the programming MENU. The machine shows this display and is ready to brew.

“INTENZA+” Water Filter Installation

We recommend you to install the “INTENZA+” water filter as this prevents limescale build-up in your machine and preserves a more intense aroma of your coffee.



The “INTENZA+” water filter can be purchased separately. For further details, please refer to the maintenance products page in this manual. Water is a crucial part of every coffee, so it is very important to always have it professionally filtered. Using the “INTENZA+” water filter will prevent mineral deposits from building up and improve your water quality.

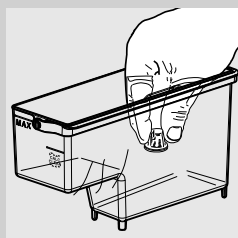

1 Remove the small white filter from the water tank and store it in a dry place.

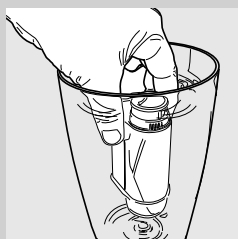

2 Remove the “INTENZA+” water filter from its packaging, immerse it vertically (with the opening positioned upwards) in cold water and gently press the sides so as to let the air bubbles out.

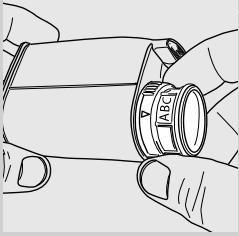

- 3** Set the "INTENZA+" water filter according to the measurements performed (see previous chapter) and indicated on the base of the filter:
 A = soft water – equals 1 or 2 on the test strip
 B = hard water (standard) – equals 3 on the test strip
 C = very hard water – equals 4 on the test strip

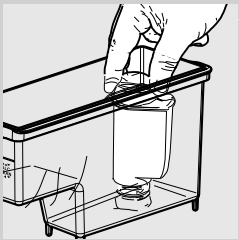

- 4** Put the "INTENZA+" water filter into the empty water tank. Press it down until it cannot move any further.

- 5** Fill the water tank with fresh water and reinsert it into the machine.

- 6** Dispense all the water of the tank by using the hot water function (see "Hot Water Dispensing" chapter).

- 7** Fill the water tank again.

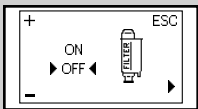

- 8** Press the "☰" button and scroll the pages by pressing the "☰" button until the following display is shown.

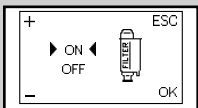

- 9** Press the "☺" button to select "ON" and press the "☰" button to confirm.

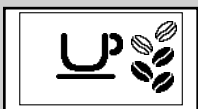

- 10** To exit, press the "☺" button. The machine shows this display and is ready to brew.

In this way the machine has been programmed to inform the user of the need to replace the "INTENZA+" water filter.

Replacing the "INTENZA+" Water Filter

When the "INTENZA+" water filter needs to be replaced with a new one, the following icon is displayed.



Yellow

- 1 Replace the "INTENZA+" water filter as described in the previous chapter.

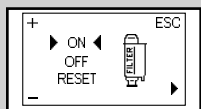

Yellow

- 2 Press the "≡" button and scroll the pages by pressing the "≡" button until the following icon is displayed.



Yellow

- 3 Select the "RESET" option. Press the "≡" button to confirm.

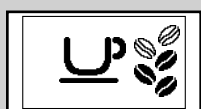

Green

- 4 To exit, press the "☑" button. The machine shows this display and is ready to brew.

The machine is now programmed to manage a new "INTENZA+" water filter.

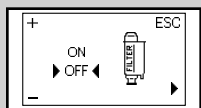

Yellow

Note:

If the "INTENZA+" water filter is already installed and you want to remove, but not replace it, select the "OFF" option instead.

If there is no "INTENZA+" water filter installed, insert the small white filter previously removed into the water tank.

ADJUSTMENTS

The machine allows for certain adjustments so that you can brew the best tasting coffee possible.

Saeco Adapting System

Coffee is a natural product and its characteristics may change according to its origin, blend and roast. The machine is equipped with a self-adjusting system that allows the use of all types of coffee beans available on the market except for caramelized and flavoured coffee beans.

The machine automatically adjusts itself after brewing several cups of coffee to optimize the extraction.

Adjusting the Ceramic Coffee Grinder

Ceramic coffee grinders always guarantee accurate and perfect grinding and coarseness for every coffee speciality.

This provides for full aroma preservation, delivering a truly Italian taste in every cup.



Warning:

The ceramic coffee grinder contains moving parts that may be dangerous. Do not insert fingers or other objects. Only adjust the ceramic coffee grinder using the grinder adjustment key.

You can adjust the ceramic grinders to set the coffee grinding to your personal taste.



Warning:

Only turn the grinder adjustment knob inside the coffee bean hopper when the ceramic coffee grinder is in use.

Adjusting the Coffee Dispensing Spout

The height of the dispensing spout can be adjusted to better fit the dimensions of the cups that you wish to use.

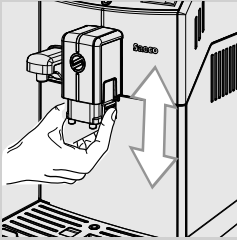

Move the dispensing spout up or down with your fingers to adjust its height as shown in the image.

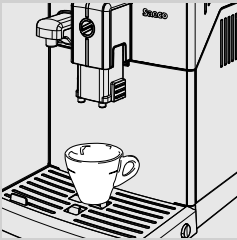

The recommended positions are:
For the use of small cups;

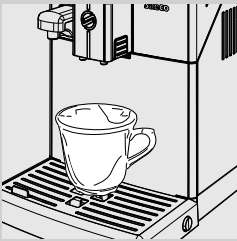

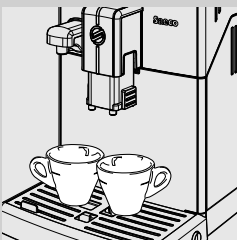

For the use of large cups.



Two cups can also be placed under the dispensing spout to brew two cups of espresso or coffee at the same time.

Adjusting the Coffee Length

The machine allows you to adjust the amount of brewed coffee according to your taste and the size of your cups.

Each time the “” or “” button is pressed, the machine brews a pre-set amount of coffee. Each button may be individually programmed for a specific brew setting.

The following procedure describes how to programme the “” button.

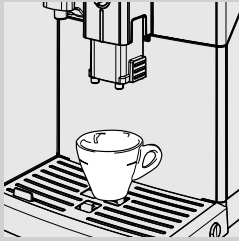

- 1 Place a cup under the dispensing spout.





Green

- 2 Press and hold the “” button until the “MEMO” icon appears on the display, then release the button. The machine is now programming. The machine starts brewing coffee.



Green



- 3 Press the “” button as soon as the desired amount of coffee is reached.

Now the “” button is programmed; each time it is pressed, the machine will brew the same amount of espresso that was just programmed.



Note:

To program the “” button, the same steps should be followed.

You should always use the “” button to stop brewing coffee when the desired amount of coffee is reached even when you are programming the “” button.

ESPRESSO AND COFFEE BREWING

Before brewing coffee, make sure that there are no warnings shown on the control panel, and that the water tank and coffee bean hopper are filled.

Espresso and Coffee Brewing Using Coffee Beans

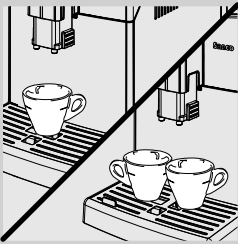

- 1 Place 1 or 2 cups under the dispensing spout.

- 2 To brew an espresso or a coffee, press the “☉” button to select the desired aroma.

- 3 Press the “☉ MEMO” button for an espresso or the “☉ MEMO” button for a coffee.



Green

- 4 To brew 1 cup of espresso or coffee, press the desired button once. This icon will be displayed.



Green

- 5 To brew 2 cups of espresso or coffee, press the desired button twice consecutively. This icon will be displayed.

Note:

In this operating mode, the machine automatically grinds and doses the correct amount of coffee. Brewing two espressos or two coffee requires two grinding and brewing cycles, automatically carried out by the machine.

- 6 After the prebrewing cycle, coffee begins to pour out of the dispensing spout.

- 7 Coffee brewing automatically stops when the pre-programmed level is reached; press the “☉ MEMO” button to stop it earlier.

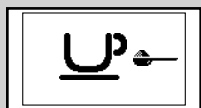

Green

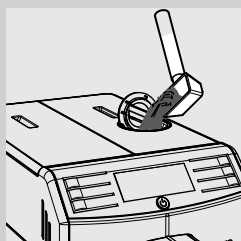

Espresso and Coffee Brewing Using Pre-Ground Coffee

This function allows you to use pre-ground coffee.

With the pre-ground coffee function you can only brew one coffee at a time.

- 1 Press the “☕” button to select the pre-ground coffee function.
 - 2 Lift the pre-ground coffee compartment lid and add one scoop of pre-ground coffee to the compartment.
Use only the measuring scoop supplied with the machine. Then close the pre-ground coffee compartment lid.
- Warning:**
Add only pre-ground coffee to the pre-ground coffee compartment. Other substances and objects may cause severe damage to the machine. Such damage will not be covered by warranty.
- 3 Press the “☕” button for an espresso or the “☕” button for a coffee.
The brewing cycle starts.
 - 4 After the prebrewing cycle, coffee begins to pour out of the dispensing spout.
 - 5 Coffee brewing automatically stops when the preset level is reached; press the “☕” button to stop it earlier.

After brewing, the machine returns to the main menu.

Repeat the steps described above to brew more coffees using pre-ground coffee.



Note:

If no pre-ground coffee is poured into the pre-ground coffee compartment, only water will be dispensed.

If the dose is excessive or 2 or more scoops of pre-ground coffee are used, the machine will not brew the product and any ground coffee will be discharged into the coffee grounds drawer.

MILK CARAFE

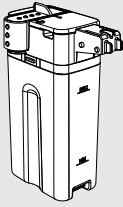

This chapter explains how to use the milk carafe to prepare a cappuccino or to froth the milk.



Note:

Before using the milk carafe, clean it thoroughly as described in the “Cleaning and Maintenance” chapter.

We recommend that you fill the carafe with cold (~5°C / 41°F) milk with a protein content of at least 3% to ensure optimum results when preparing a cappuccino. Whole milk or skimmed milk may be used depending on individual taste.



Warning:

Do not use any other liquids than water for cleaning or milk.

Filling the Milk Carafe

The milk carafe can be filled before use or even during use.

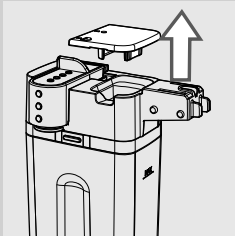

- 1 Lift the carafe lid as shown in the figure.

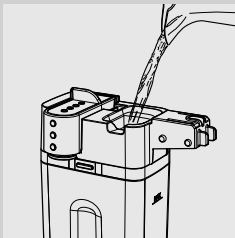

- 2 Pour the milk into the milk carafe: the milk level must be between the minimum (MIN) and maximum (MAX) level indicator shown on the milk carafe.

- 3 The milk carafe is now ready to use.

Inserting the Milk Carafe

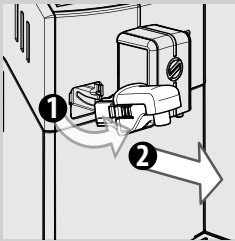

- 1 If installed, remove the water dispensing spout as shown in the figure:
 - Press the two buttons on the side to unlock it and lift it slightly;
 - Pull the water dispensing spout to remove it.

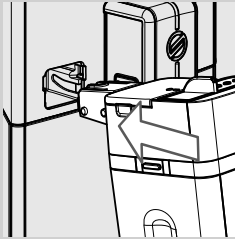

- 2 Slightly tilt the milk carafe. Insert it all the way into the guides of the machine.

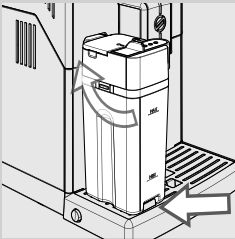

- 3 Push the carafe towards the bottom while rotating at the same time, until it is locked at the drip tray. Do not use force while inserting the carafe.

Removing the Milk Carafe

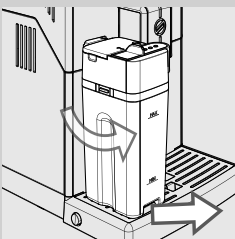

- 1 Rotate the carafe upwards until it releases from the insert in the drip tray. Then remove it.

Emptying the Milk Carafe

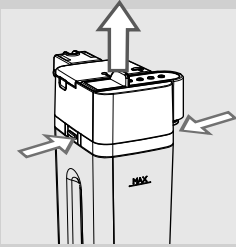

- 1 Press the release buttons to remove the top of the carafe.

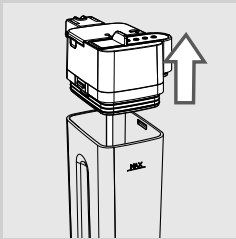

- 2 Lift the top of the carafe. Empty the milk carafe and clean it properly.



Note:

After each use, clean the milk carafe as described in the "Cleaning and Maintenance" chapter.

CAPPUCCINO BREWING

**Warning:**

Danger of scalding! Dispensing may be preceded by short sprays of milk and steam. Danger of burns! Wait until the end of the cycle before removing the milk carafe.

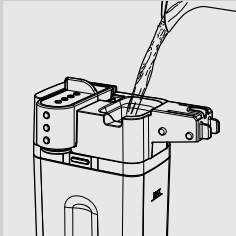
**1**

Fill the milk carafe with milk. The level must be between the minimum (MIN) and maximum (MAX) indication on the milk carafe.

**Note:**

Use cold (~5 °C / 41°F) milk with a protein content of at least 3% to ensure optimum results when preparing a cappuccino. Whole milk or skimmed milk may be used depending on individual taste.

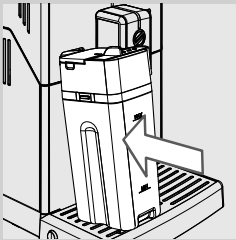
**2**

Insert the carafe into the machine.

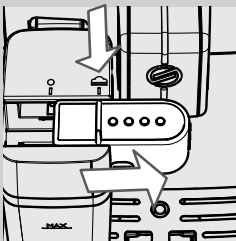
**3**

Pull out the milk carafe dispenser to the right up to the “” icon.

**Note:**

If the milk carafe dispenser has not been pulled all the way out, steam may escape and the milk may not be properly frothed.

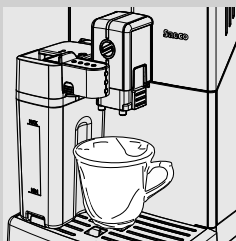
**4**

Place a cup under the dispensing spout.

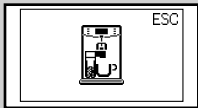
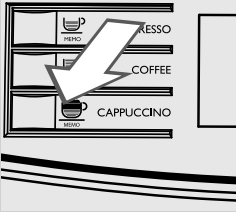

Green

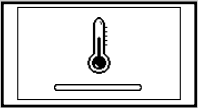

Yellow



Verde



Verde

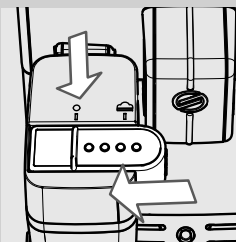

5 Press the “” button to start the dispensing.

6 The machine reminds you to insert the carafe and pull out the milk carafe dispenser.

7 This icon is displayed during pre-heating time required by the machine.

8 When the machine shows the following icon, the machine pours the milk. Dispensing can be stopped by pressing the “” button.

9 Once the milk froth has been poured, the machine dispenses the coffee. Dispensing can be stopped by pressing the “” button.

10 Put back the milk carafe dispenser, by shifting it up to the “●” icon.

 **Note:**

After using the milk carafe, clean it as described in the "Cleaning and Maintenance" chapter.

It is possible to prepare a cappuccino with pre-ground coffee. Press the “” button to select pre-ground coffee and pour the pre-ground coffee into the compartment.

Adjusting the Cappuccino Length

Each time the “☕” button is pressed, the machine pours a pre-set quantity of cappuccino into the cup.

The machine allows you to adjust the amount of cappuccino brewed according to your taste and the size of your cups.

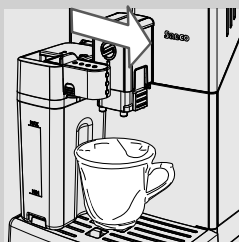

- 1 Fill the milk carafe with milk and install it in the machine.
- 2 Pull out the milk carafe dispenser to the right up to the “☕” icon. Place a cup under the dispensing spout.

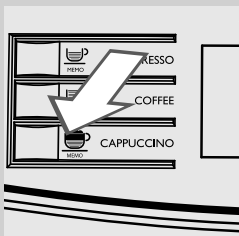

- 3 Press and hold the “☕” button until the “MEMO” icon appears on the display. Then release the button. The machine is now programming.

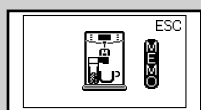

Green

- 4 The machine reminds you to insert the carafe and pull out the milk carafe dispenser.

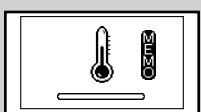

Yellow

- 5 This icon is displayed during pre-heating time required by the machine.



Green

- 6 When the machine shows this icon, the machine starts to dispense milk froth into the cup. When the desired quantity of milk froth is reached, press the “☕” button.



Green

- 7 Once the milk froth has been poured, the machine starts dispensing the coffee. When the desired coffee quantity is reached, press the “☕” button.

Now the “☕” button is programmed. Every time it is pressed, the machine will brew the same amount of cappuccino that was programmed.

FROTHING MILK

**Warning:**

Danger of scalding! Dispensing may be preceded by short sprays of milk and steam. Danger of burns!

Wait until the end of the cycle before removing the milk carafe.

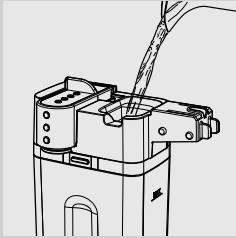

- 1 Fill the milk carafe with milk. The level must be between the minimum (MIN) and maximum (MAX) indication on the milk carafe.

**Note:**

Use cold (~5 °C / 41°F) milk with a protein content of at least 3% to ensure optimum results when preparing a cappuccino. Whole milk or skimmed milk may be used depending on individual taste.

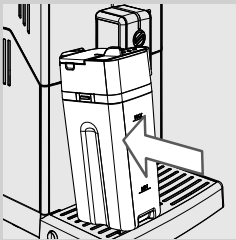

- 2 Insert the carafe into the machine.

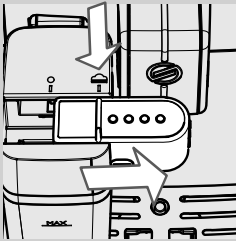

- 3 Pull out the milk carafe dispenser to the right up to the "☁" icon.

**Note:**

If the milk carafe dispenser has not been pulled all the way out, steam may come out and the milk may not be properly frothed.

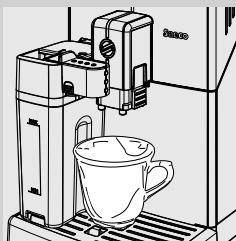

- 4 Place a cup under the dispensing spout.

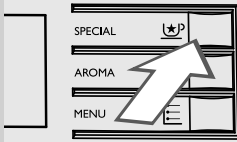

5 Press the “☺” button. The machine shows this display.



6 Press the “☺” button to select milk froth.

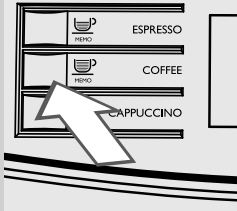

7 The machine reminds you to insert the carafe and pull out the milk carafe dispenser.

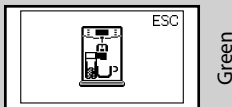

8 This icon is displayed during pre-heating time required by the machine.

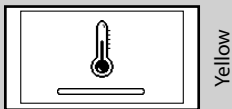

9 The machine dispenses a predefined quantity of milk froth into the cup. Dispensing can be stopped by pressing the “☺” button.



10 Put back the milk carafe dispenser by shifting up to the “●” icon.

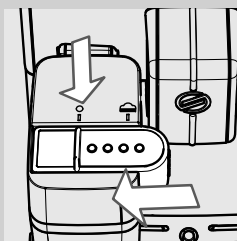

Note:

After using the milk carafe, clean it as described in the "Cleaning and Maintenance" chapter.

Adjusting the Milk Froth Length

Each time this function is selected, the machine dispenses a preset amount of milk froth into the cup. The machine allows you to adjust the amount of milk froth according to your taste and the size of your cups.

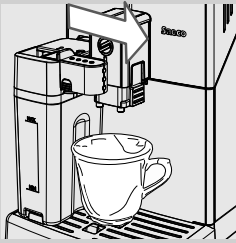

1 Fill the milk carafe with milk and install it in the machine.

2 Pull out the milk carafe dispenser to the right up to the "☕" icon. Place a cup under the dispensing spout.

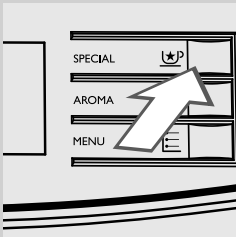

3 Press the "☕" button. The machine shows this display.



4 Press and hold the "☕" button to select milk froth until the "MEMO" icon appears on the display. Then release the button. The machine is now programming.

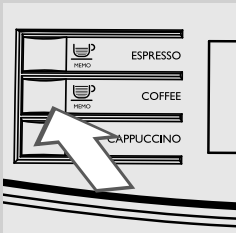

5 The machine reminds you to insert the carafe and pull out the milk carafe dispenser.

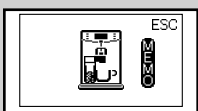

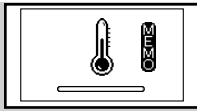

Yellow

- 6** This icon is displayed during pre-heating time required by the machine.



Green

- 7** When the desired amount of milk froth is reached, press the “MEMO” button.

Now the “milk froth” button is programmed. Every time it is pressed, the machine will brew the same amount of milk froth that was programmed.

DISPENSING HOT WATER



Warning:

Danger of scalding! Dispensing may be preceded by short sprays of hot water and steam. Danger of burns! Wait until the end of the cycle before removing the water dispensing spout.

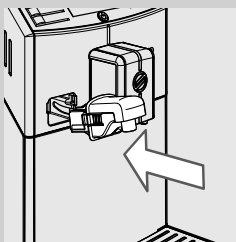

- 1** Slightly tilt the water dispensing spout and insert it all the way in into the guides of the machine.

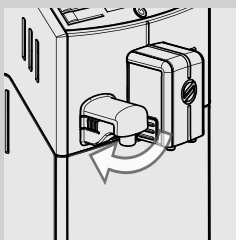

- 2** Push the water dispensing spout towards the bottom while rotating at the same time, until it is locked in the machine as shown in the figure.

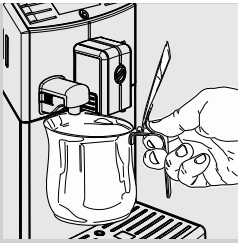

3 Place a container under the hot water dispensing spout.

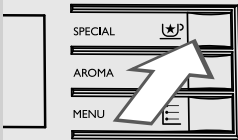

4 Press the “★” button. The machine shows this display.



Green

5 Press the “☿” button to start the dispensing.

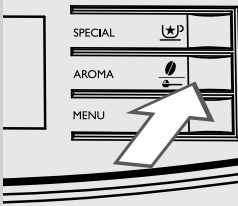

6 This icon is displayed. The machine reminds you to install the water dispensing spout. Check that the water dispensing spout is correctly installed. Press “MEMO” to confirm. The machine will start dispensing hot water.

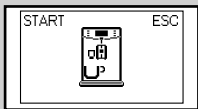

Green

7 This icon is displayed during pre-heating time required by the machine.

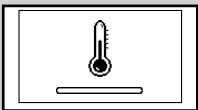

Yellow

8 Pour the desired amount of hot water. To stop the hot water dispensing press the “MEMO” button.



Green

CLEANING AND MAINTENANCE

Daily Cleaning of the Machine



Caution:

Timely cleaning and maintenance of your machine is very important as it prolongs the life of your machine. Your machine is continuously exposed to moisture, coffee and limescale!

In this chapter it is described in detail which activities you need to perform at which frequency. Not doing this will ultimately make your machine stop working properly. This repair is NOT covered by your warranty!



Note:

- Use a soft, dampened cloth to clean the machine.
- Only the cup holder grill and all parts of the carafe can be washed in the dishwasher. All other components must be washed with lukewarm water.
- Do not immerse the machine in water.
- Do not use alcohol, solvents, and/or abrasive objects to clean the machine.
- Do not dry the machine and/or its components using a microwave and/or standard oven.

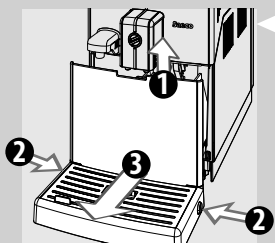

1 Empty and clean the coffee grounds drawer and the drip tray daily with the machine turned on.

- 1 Raise the coffee dispensing spout;
- 2 Press the side buttons;
- 3 Remove the drip tray.

Other maintenance operations can only be carried out when the machine is turned off and unplugged.

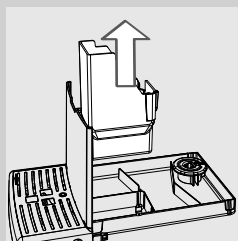

2 Remove the coffee grounds drawer and empty it.

3 Empty and clean the drip tray.

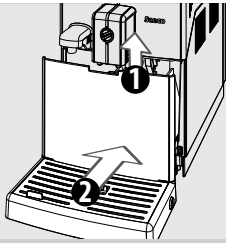

- 4 Insert the coffee grounds drawer back into the drip tray and this into the machine.

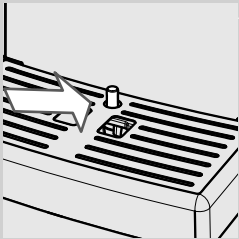
**Note:**

Also empty the drip tray and coffee grounds drawer when the full drip tray indicator is raised.

Daily Cleaning of the Water Tank

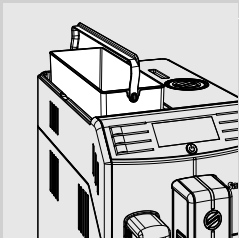

- 1 Remove the small white filter or the "INTENZA+" water filter (if installed) from the water tank and wash it with fresh water.
- 2 Put the small white filter or the "INTENZA+" water filter (if installed) back in its housing by gently pressing and turning it at the same time.
- 3 Fill the water tank with fresh water.

Daily Cleaning of the Milk Carafe

It is important that you clean the milk carafe daily or after each use as it preserves hygiene and ensures perfect milk froth consistency.



Warning:

Danger of scalding! Dispensing may be preceded by short sprays of hot water and steam. Danger of burns! Wait until the end of the cycle before removing the milk carafe.

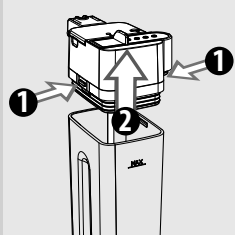

- 1 Press the release buttons to remove the top of the carafe.

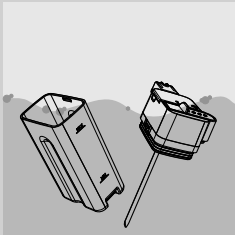

- 2 Rinse the top of the carafe and the milk carafe with lukewarm water. Remove all milk residues.

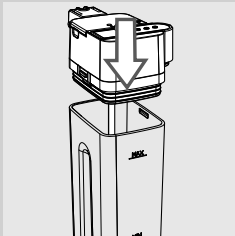

- 3 Insert the top of the milk carafe, ensuring it is locked into place.

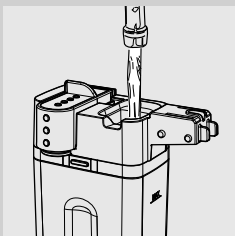

- 4 Remove the lid and fill the milk carafe up to the MAX level with fresh water.

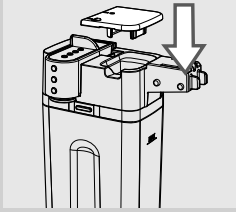

5 Put the lid back onto the milk carafe.

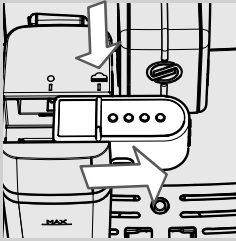

6 Pull out the milk carafe dispenser to the right up to the "☕" icon.

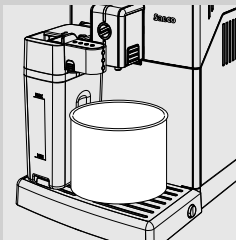

7 Place a container under the dispensing spout.

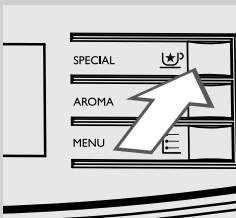

8 Press the "☕" button. The machine shows this display.



Green

9 Press the "☕" button to select milk froth.

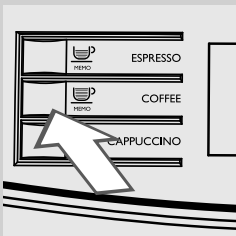

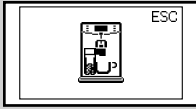

Green

10 The machine reminds you to insert the carafe and pull out the milk carafe dispenser.

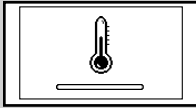

Yellow

11 This icon is displayed during pre-heating time required by the machine.



Green

12 Once the machine stops dispensing water, the cleaning is finished.

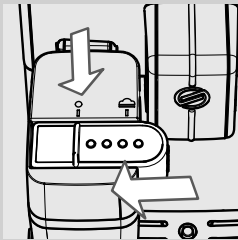

13 Put back the milk carafe dispenser by shifting it up to the "●" icon. Remove the milk carafe and empty it.

Weekly Cleaning of the Machine

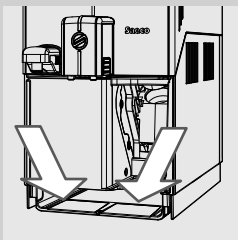

1 Clean the seat of the drip tray.

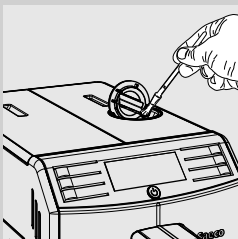

2 Clean the pre-ground coffee compartment with the cleaning brush.

Weekly Cleaning of the Milk Carafe

The weekly cleaning is more thorough since all milk residue is removed from the dispenser.

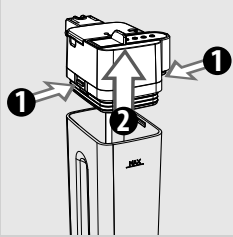

- 1** Press the release buttons to remove the top of the carafe.

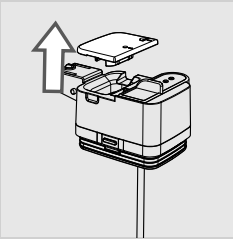

- 2** Remove the lid.

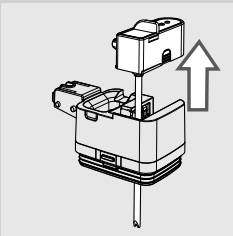

- 3** Lift the milk carafe dispenser to remove it from the top of the carafe. The milk carafe dispenser is made up of five parts that must be disassembled. Each part is identified by a capital letter (A, B, C, D, E) as shown in the figures below.

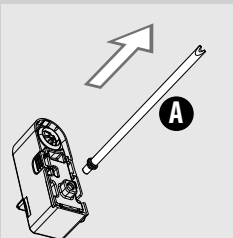

- 4** Remove the suction tube with the fitting (A) from the milk frother.

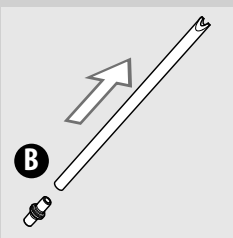

- 5** Remove the fitting (B) from the tube.

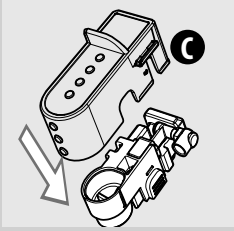

6 Detach the lid (C) from the milk carafe dispenser by pulling it down while slightly pressing on the sides.

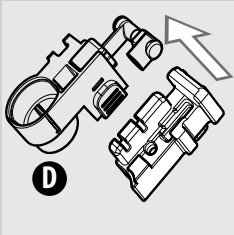

7 Disassemble further as shown in the figure.

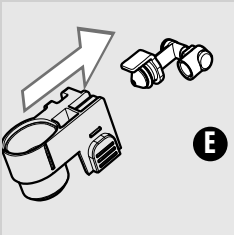

8 Pull the fitting (E) outwards from the milk frothing device.

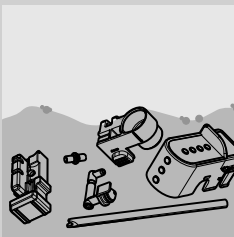

9 Clean all the parts thoroughly with lukewarm water.



Note:

You can also clean these parts in the dishwasher.

10 Reassemble the parts following the reverse order.

Weekly Cleaning of the Brew Group

The brew group should be cleaned every time the coffee bean hopper is filled or at least once a week.

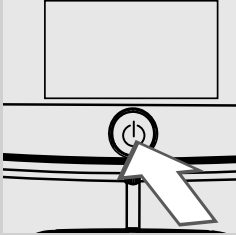

- 1 Turn off the machine by pressing the "⏻" button. Wait until the "⏻" button flashes and unplug the power cord.

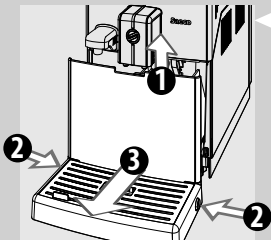

- 2 Raise the coffee dispensing spout and remove the drip tray and coffee grounds drawer by pressing the side buttons. Only at this time open the service door.

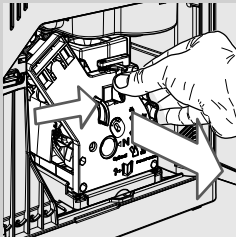

- 3 To remove the brew group, press the «PUSH» button. Pull it horizontally by the handle without turning it.

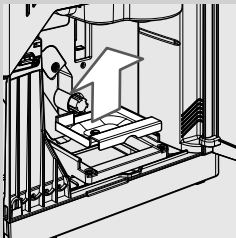

- 4 Remove the coffee residues drawer and wash it thoroughly.

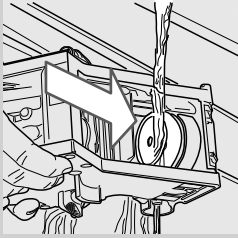

5 Thoroughly wash the brew group with lukewarm water and carefully clean the upper filter.

! **Caution:**

Do not use detergent or soap to clean the brew group.

6 Let the brew group air-dry thoroughly.

7 Thoroughly clean the inside of the machine using a soft, dampened cloth.

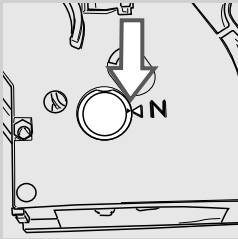

8 Make sure the brew group is in the rest position; the two reference signs must match. If they do not match, proceed as described in steps 9-10.

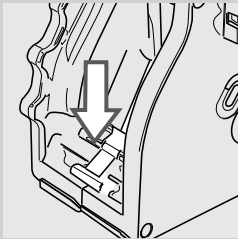

9 Gently pull down the lever until it is in contact with the brew group base and the two reference signs on the side of the brew group match.

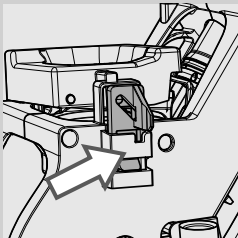

10 Make sure the hook to lock the brew group is in the correct position by firmly pressing the "PUSH" button until it locks into place. Check if the hook is at the top end position. If it is not, please try again.

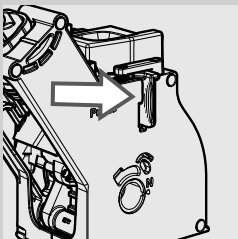

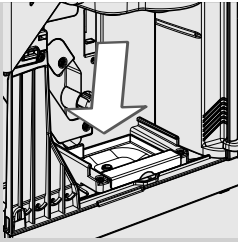

- 11** Insert the coffee residues drawer in its seat and ensure that it is correctly in place.



Note:

If the coffee residues drawer is not correctly positioned, the brew group may not fit into the machine.

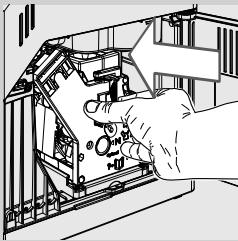

- 12** Insert the brew group in its seat again until it locks into place without pressing the "PUSH" button.

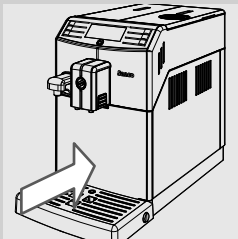

- 13** Insert the coffee grounds drawer with the drip tray back into the machine and close the service door.

Monthly Cleaning of the Milk Carafe

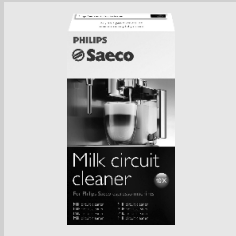

For the monthly cleaning cycle we recommend using the “Saeco Milk Circuit Cleaner” to keep the entire circuit clean of milk residues. The “Saeco Milk Circuit Cleaner” can be purchased separately. Please refer to the maintenance products page for further details.



Warning:

Danger of scalding! Dispensing may be preceded by short sprays of hot water and steam. Danger of burns! Wait until the end of the cycle before removing the milk carafe.



Note:

Before starting the procedure, make sure that the water tank is filled up to the MAX level.

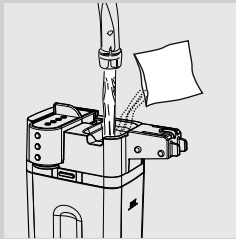

1 Fill the milk carafe with water up to the maximum level (MAX).

2 Pour the milk cleaner bag into the milk carafe and let it dissolve completely.

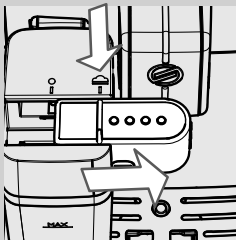

3 Insert the carafe into the machine. Pull out the milk carafe dispenser to the right up to the “” icon.

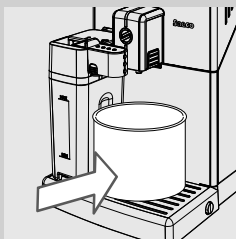

4 Place a container under the dispensing spout.

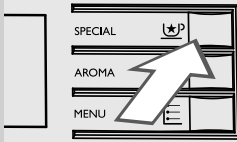

5 Press the "☺☺" button. The machine shows this display.



6 Press the "☺☺" button to select milk froth.



7 The machine reminds you to insert the carafe and pull out the milk carafe dispenser.

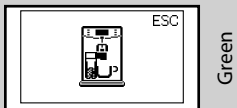

8 This icon is displayed during pre-heating time required by the machine.

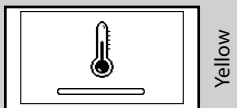

9 Once the machine stops dispensing water, repeat steps 5 - 8 until the carafe is emptied.

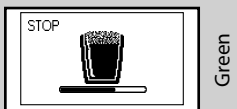

⚠ Warning:
Never drink the solution dispensed during this step.

10 Put back the milk carafe dispenser by shifting it up to the "●" icon. Remove the milk carafe.

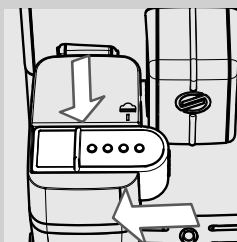

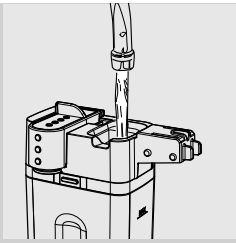

11 Remove the milk carafe and the container from the machine.

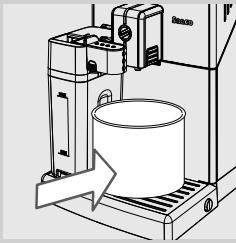

12 Insert the milk carafe into the machine. Pull out the milk carafe dispenser to the right up to the "☕" icon. Place a container under the dispensing spout to activate the rinse cycle.

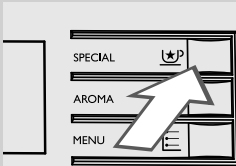

14 Press the "☕★" button. The machine shows this display.



15 Press the "☕" button to select milk froth.

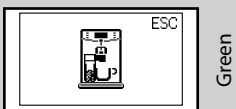
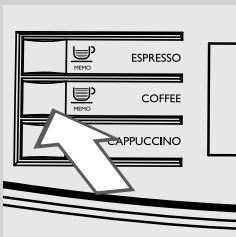

16 The machine reminds you to insert the carafe and pull out the milk carafe dispenser.

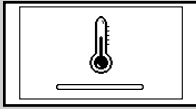

Yellow



Green

17 This icon is displayed during pre-heating time required by the machine.

18 Once the machine stops dispensing water, repeat steps 13 - 16 until the carafe is emptied.

19 Remove the milk carafe and the container from the machine. Repeat steps 11 - 16 one more time.

20 Disassemble and wash the milk carafe as described in the "Weekly Cleaning of the Milk Carafe" chapter.

Monthly Lubrication of the Brew Group

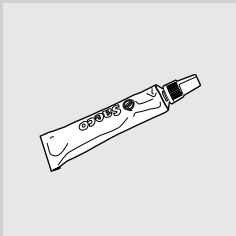

Lubricate the brew group after approximately 500 coffees or once a month. The grease to lubricate the brew group can be purchased separately. For further details, please refer to the maintenance products page in this manual.



Caution:

Before lubricating the brew group, clean it with fresh water and let it dry, as described in the "Weekly Cleaning of the Brew Group" chapter.

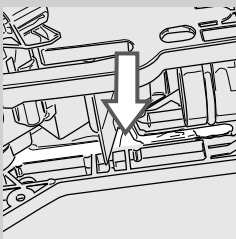
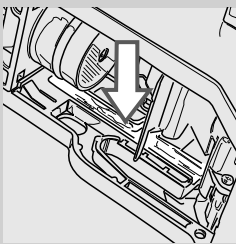

1 Apply the grease evenly on both side guides.

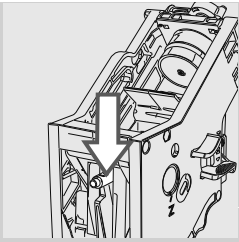

- 2** Also lubricate the shaft.

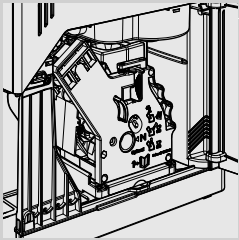
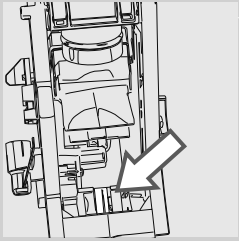

- 3** Insert the brew group in its seat until it locks into place (see “Weekly Cleaning of the Brew Group” chapter).

- 4** Close the service door and insert the drip tray and coffee grounds drawer.

Monthly Cleaning of the Brew Group with “Coffee Oil Remover”



Besides weekly cleaning, we recommend running the cleaning cycle with “Coffee Oil Remover” after approximately 500 coffees or once a month. This operation completes the maintenance process for the brew group. You can purchase separately the “Coffee Oil Remover”. For further details, please refer to the maintenance products page in this manual.



Caution:

The “Coffee Oil Remover” tablets are to be used for cleaning only and do not have a descaling function. For the descaling procedure use the Saeco descaling solution and follow the procedure described in the “Descaling” chapter.



1 Place a container under the dispensing spout.

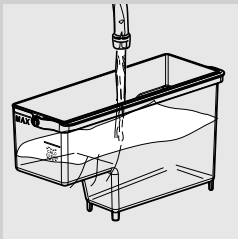

2 Make sure the water tank is filled with fresh water up to the "MAX" level.

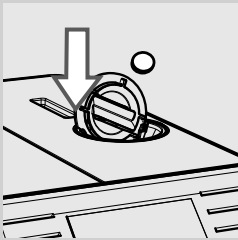

3 Put a "Coffee Oil Remover" tablet in the pre-ground coffee compartment.

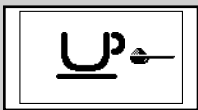

Green

4 Press the "☕" button to select the pre-ground coffee function. Do not add ground coffee.

5 Press the "MEMO" button to start the coffee brewing cycle.

6 Wait until the machine has dispensed half a cup of water.

7 Switch the power button on the back of the machine to "0".

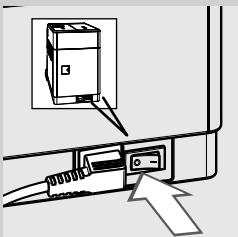

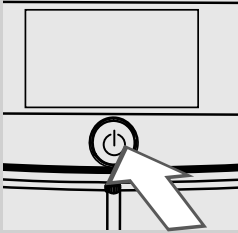

8 Let the solution take effect for about 15 minutes. Empty the container.

9 Switch the power button on the back of the machine, to "I". To turn on the machine, press the "⏻" button.
Wait until the automatic rinse cycle has been completed.

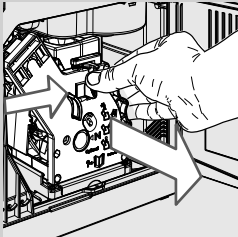

10 Remove the drip tray and the coffee grounds drawer, empty them and open the service door. Remove the brew group.

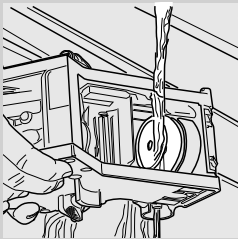

11 Wash the brew group thoroughly with fresh water.

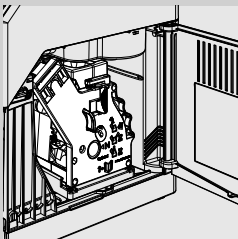

12 After rinsing the brew group, insert it again in its seat until it locks into place (see "Weekly Cleaning of the Brew Group" chapter). Insert the drip tray and the coffee grounds drawer. Close the service door.



Green

- 13** Press the “☕” button to select the pre-ground coffee function. Do not add ground coffee.
- 14** Press the “☕” button to start the coffee brewing cycle.
- 15** Repeat steps 13 to 14 twice. Empty the container.

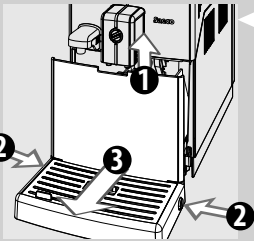

- 16** To clean the drip tray, place “Coffee Oil Remover” tablet inside and fill it 2/3rds full with hot water. Let the cleaning solution take effect for about 30 minutes, then rinse thoroughly.

Monthly Cleaning of the Coffee Bean Hopper

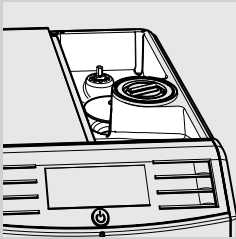

Clean the coffee bean hopper once a month when it is empty with a damp cloth to remove coffee oil. Thereafter refill it with coffee beans.

DESCALING

The descaling process takes approx. 35 minutes.



Yellow

Limescale builds up inside the machine during use. It needs to be removed regularly as it may clog the water and coffee circuit of your machine. The machine tells you when descaling is needed. If the machine display shows the **CALC CLEAN** icon, it means that you need to descale it.

**Caution:**

Not doing this will ultimately make your machine stop working properly, and in this case repair is NOT covered by your warranty.



Use the Descaling solution only. Its formula has been designed to ensure better machine performance.

You can purchase separately the Descaling solution. Please refer to the maintenance products page in this user manual for further details.

**Warning:**

Never drink the descaling solution or any products dispensed until the cycle has been carried out to the end. Never use vinegar as a descaling solution.

**Note:**

During the descaling cycle do not switch off the machine. If this has happened you have to restart the descaling cycle to fully complete it. It will restart from the point the descaling cycle had previously been left.

To execute the descaling cycle, follow the steps below:

Before descaling:

- 1 Empty the drip tray and the coffee grounds drawer.

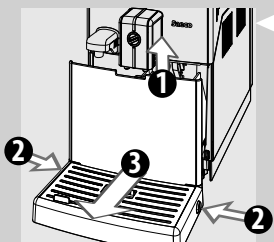

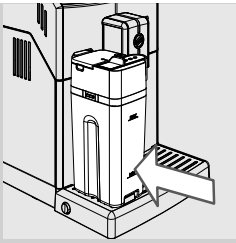

2 Insert the empty milk carafe.

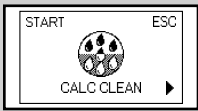

Yellow

3 Remove the "INTENZA+" water filter from the water tank if it was installed and replace it with the small white original one. Place the water tank back into the machine.

4 Press the "☰" button until the following display is shown.

5 Press the "☺" button to start the descaling process.

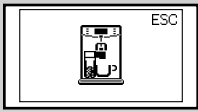

Yellow

6 The machine reminds you to insert the carafe and pull out the milk carafe dispenser.

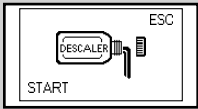

Yellow



Note:

If you press the "☺" button by mistake, press the "☒" button to quit.

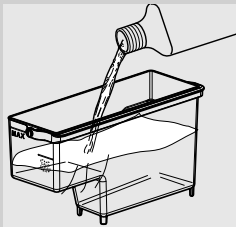

7 Remove the water tank and pour in the entire contents of the descaling solution. Then top up the tank with fresh water up to the **CALC CLEAN** level.

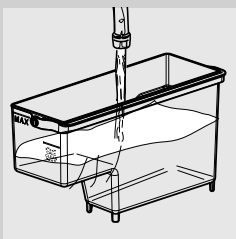

8 Place the water tank back into the machine.

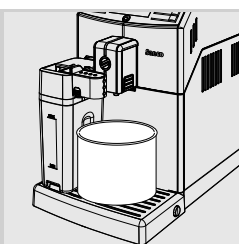

9 Pull out the milk carafe dispenser to the right up to the “☕” icon. Place a large container (1.5 l) under both the milk carafe dispenser and the dispensing spout.

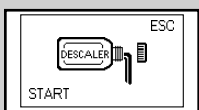

Yellow

10 Press the “☕” button to start the descaling cycle.

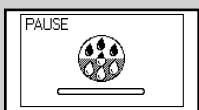

Yellow

11 The machine will start dispensing the descaling solution at intervals. The bar on the control panel shows the cycle progress.

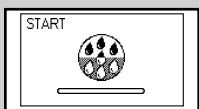

Yellow

Note:
The descaling cycle may be paused by pressing the “☕” button. To resume the cycle, press the “☕” button again. This allows you to empty the container or to stay away from the machine for a brief period of time.



Red

12 When this icon is displayed, the water tank is empty.

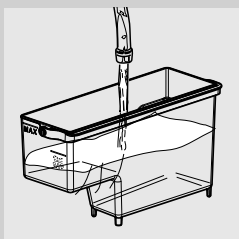

13 Remove the water tank, rinse it and fill it up to the MAX level with fresh water. Place it back into the machine.

14 Remove and empty the container and the milk carafe.

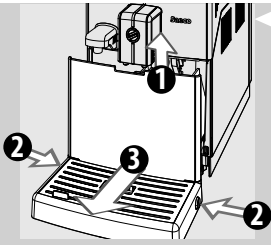

15 Empty the drip tray and place it back.

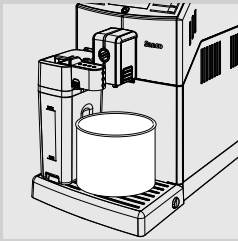

16 Install the milk carafe into the machine. Pull out the milk carafe dispenser to the right up to the "☕" icon. Place the container back under both the milk carafe dispenser and the dispensing spout.



Yellow

17 Press the "☕" button to start the rinse cycle.

Note:

The rinse cycle may be paused by pressing the "☕" button. To resume the cycle, press the "☕" button again. This allows you to empty the container or to stay away from the machine for a brief period of time.



Red

18 When this icon is displayed, the water tank is empty. Repeat steps 13-17. When the machine shows this icon again, go to step 19.

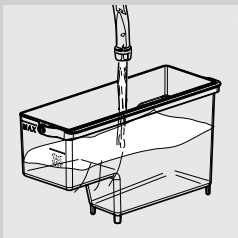

19 When the water tank is empty, remove the water tank, rinse it and fill it up to the MAX level with fresh water. Place it back into the machine.

20 Empty the container and place it back under the dispensing spout.

Note:

The circuit needs to be cleaned with a preset amount of water. If you had not filled up the water tank to MAX level, the machine might require three or more tanks for rinsing.

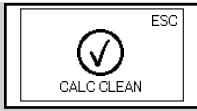

Green



Yellow

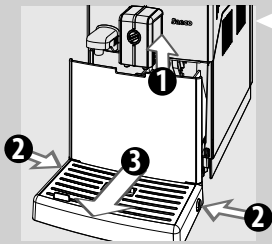

21 When the amount of water needed for the rinse cycle has been completely dispensed, this icon on the side is displayed. Press the “” button to quit the descaling cycle.

22 The machine automatically primes the circuit.

23 The machine now carries out the warm-up and automatic rinse cycle to prepare for product brewing.

24 Remove and empty the container.

25 Empty the drip tray and place it back.

26 The descaling cycle is now complete.

27 Remove the small white water filter and place back the “INTENZA+” water filter (if installed) to the water tank.

 **Note:**

At the end of the descaling cycle, wash the brew group as described in the “Weekly Cleaning of the Brew Group” chapter.

PROGRAMMING

You can adjust the machine functions to your personal preference by accessing the program menu.

The following settings can be adjusted



Yellow

Coffee temperature

This function allows you to adjust the coffee brewing temperature.

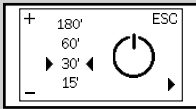

Yellow

Timer (stand-by)

This function allows you to manage stand-by time.

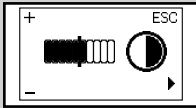

Yellow

Contrast

This function allows you to adjust the contrast of the display to better view the messages.

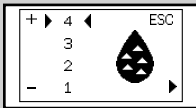

Yellow

Water hardness

'This function allows you to adjust the water hardness setting according to the area where you live.'

- 1 = very soft water
- 2 = soft water
- 3 = hard water
- 4 = very hard water

For more details, please see the "Measuring and Programming Water Hardness" chapter.

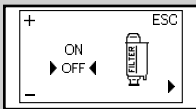

Yellow

"INTENZA+" Water Filter

This function allows you to manage the "INTENZA+" water filter. For more details, see the chapter about filter handling.

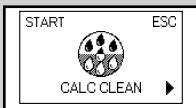

Yellow

Descaling cycle

This function allows you to run the descaling cycle.

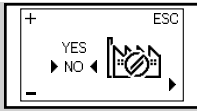

Yellow

Factory settings

This function allows you to reset all factory values.

How to Program the Machine

In this example, it is shown how to program the display contrast. Proceed in the same way to program the other functions.



Green

The programming menu can only be accessed when the machine is on and shows this display.

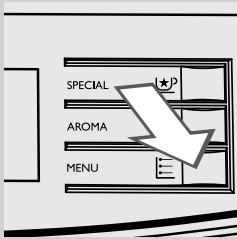

- 1 Press the "☰" button to access programming.

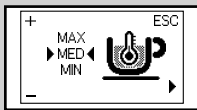

Yellow

- 2 The main screen will be displayed.

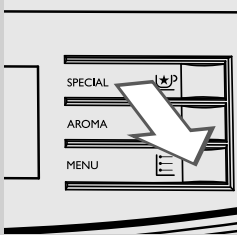

- 3 Press the "☰" button to scroll the pages until the display contrast function is displayed.

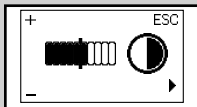

Yellow

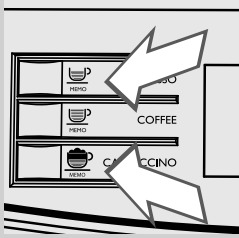

4 Press the “☕” and “☕” buttons to increase or decrease the value of the function.



5 When the display value is changed, the “OK” message appears. Press the “OK” button to confirm the change.

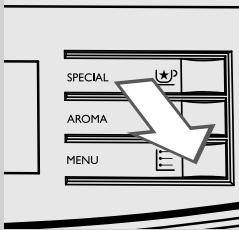

6 Press the “★” button to exit the programming menu.

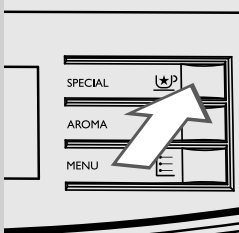

Note:

The machine will automatically exit the programming menu if you do not push any button for 3 minutes. The values that have been changed but not confirmed won't be saved.

MEANING OF THE DISPLAY ICONS

This machine is equipped with a colour-coded system to make the user's understanding of the display signals easier. The icons are colour-coded according to the traffic light principle.

Ready Signals (Green Colour)



The machine is ready to brew products.

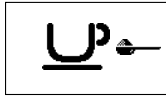

The machine is ready to brew pre-ground coffee.

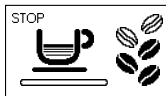

The machine is brewing one cup of espresso.

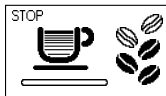

The machine is brewing one cup of coffee.

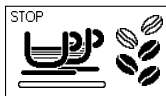

The machine is brewing two cups of espresso.

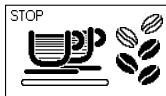

The machine is brewing two cups of coffee.



The machine is programming the amount of coffee to be brewed.

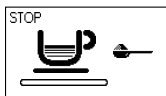

Coffee brewing using pre-ground coffee in progress.



Milk froth or hot water selection.

Ready Signals (Green Colour)



Hot water dispensing.



Milk froth brewing.



The machine is frothing the milk for the cappuccino.



The machine is brewing the coffee for the cappuccino.



The machine is programming the amount of milk to dispense for cappuccino.





The machine is programming the amount of coffee to be brewed for cappuccino.

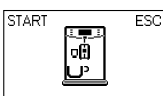

The machine is programming the amount of milk to dispense for milk froth.



Insert the water dispensing spout and press the “” button to start dispensing.
Press “” to exit.

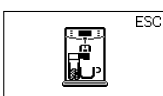

The machine will remind the user that the carafe must be inserted.

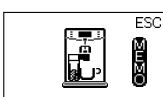

The machine will remind the user that the carafe must be inserted when programming a product containing milk.

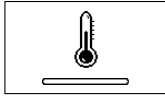
Warning Signals (Yellow Colour)

The machine is heating up to brew beverages or dispense hot water/steam.



The machine is performing the rinse cycle. Wait until the machine has completed the cycle.



The machine needs the "INTENZA+" water filter to be replaced.



The brew group is being reset due to machine reset.



Refill the coffee bean hopper with coffee beans and restart the cycle.



The machine automatically primes the water circuit.



The machine needs to be descaled. Press the "☺" button to start the descaling process. Follow the steps described in the "Descaling" chapter of this manual.

If you want to descale later, press the "☺" button to continue using the machine.

Please note that not descaling your machine will ultimately make it stop working properly. In this case repair is NOT covered under your warranty.

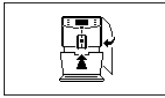
Warning Signals (Red Colour)

Completely insert the drip tray with the coffee grounds drawer into the machine and close the service door.

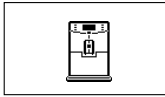

Fill the coffee bean hopper.



The brew group must be inserted into the machine.

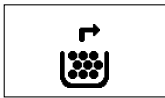

Empty the coffee grounds drawer. Wait about 5 seconds before placing it back.



Fill the water tank.

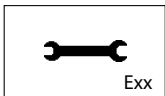



Turn off the machine. After 30 seconds, turn it on again. Try this 2 or 3 times. If the machine does not start, contact the Philips SAECO hotline in your country and communicate the Error-code which you see on the display. You can find its contact details in the warranty booklet packed separately or on www.philips.com/support.

TROUBLESHOOTING

This chapter summarizes the most common problems you could encounter with your machine.

If you are unable to solve the problem with the information below, visit www.philips.com/support for a list of frequently asked questions or contact the Philips Saeco hotline in your country.

The contact details can be found in the warranty booklet supplied separately or on www.philips.com/support.

Machine actions	Causes	Solutions
The machine does not switch on.	The machine is not connected to the electric network, or the power button is in the "O" position.	Connect the machine to the electric network and turn the power button to the "I" position.
The drip tray gets filled although no water is drained.	Sometimes water is drained automatically by the machine into the drip tray to manage the rinsing of the circuits and ensure optimum machine performance.	This is seen as normal machine behaviour.
The red  icon is always displayed on the machine.	The coffee grounds drawer was emptied with the machine off.	The coffee grounds drawer must always be emptied with the machine on. Wait until the  icon is displayed before refitting the drawer.
Coffee is not hot enough.	The cups are cold.	Preheat the cups with hot water.
Coffee does not have enough crema. (See note)	The blend is unsuitable, coffee is not freshly roasted or the grind is too coarse.	Change coffee blend or adjust the grinder as explained in chapter "Adjusting the ceramic coffee grinder."
The machine takes a long time to warm up or the amount of water dispensed is too little.	The machine circuit is clogged by limescale.	Descale the machine.
The brew group cannot be removed.	The brew group is out of place.	Turn the machine on. Close the service door. The brew group automatically returns to the initial position.
	The coffee grounds drawer is still inserted.	Remove the coffee grounds drawer before removing the brew group.
The machine grinds the coffee beans but no coffee comes out. (See note)	There is no water.	Fill the water tank and prime the circuit (see "Using the Machine for the First Time" chapter).
	The brew group is dirty.	Clean the brew group (see "Weekly Cleaning of the Brew Group" chapter).
	The circuit is not primed.	Prime the circuit (see "Using the Machine for the First Time" chapter).
	This might occur when the machine is automatically adjusting the dose.	Brew a few cups of coffee as described in the "Saeco Adapting System" chapter.
Coffee is too weak. (See note)	The dispensing spout is dirty.	Clean the dispensing spout.
	This might occur when the machine is automatically adjusting the dose.	Brew a few cups of coffee as described in the "Saeco Adapting System" chapter.

Machine actions	Causes	Solutions
Coffee is brewed slowly. (See note)	The coffee grind is too fine.	'Change coffee blend or adjust the grinder as explained in chapter "Adjusting the ceramic coffee grinder.'
	The circuit is not primed.	Prime the circuit (see "Using the Machine for the First Time" chapter).
	The brew group is dirty.	Clean the brew group (see "Weekly Cleaning of the Brew Group" chapter).
Coffee leaks out of the dispensing spout.	The dispensing spout is clogged.	Clean the dispensing spout and its holes.
Frothed milk is too cold.	The cups are cold.	Preheat the cups with hot water.
The milk is not frothed.	The milk carafe is dirty or not inserted correctly.	Clean the carafe and insert it correctly.
The milk does not come out.	The milk carafe dispenser has not been pulled out correctly.	Check that the milk dispenser has been pulled out correctly.
	The milk carafe is not fully assembled.	Make sure that all components have been correctly assembled.

**Note:**

* These problems can be considered normal if the coffee blend has been changed or if the machine has just been installed. In this case wait until the machine performs a self-adjusting operation as described in the "Saeco Adapting System" chapter.

ENERGY SAVING

Stand-by

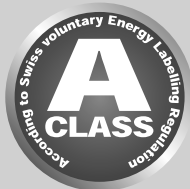

The Saeco full automatic espresso machine is designed for energy saving proven by the Class A energy label.

After 30 minutes of inactivity, the machine turns off automatically (unless a different stand-by time has been programmed). If a product has been brewed the machine performs a rinse cycle.

In stand-by mode, the energy consumption is below 1Wh. To turn on the machine, press the "⏻" button (if power button on the back of the machine is set to "I"). If the boiler is cold the machine performs a rinse cycle.

Disposal



Do not throw away the machine with the normal household waste at the end of its life, but hand it in at an official collection point for recycling. By doing this, you help to preserve the environment.

- The packing materials can be recycled.
- Machine: unplug the machine and cut the power cord.
- Deliver the appliance and power cord to a service centre or public waste disposal facility.

This product complies with EU Directive 2002/96/EC. The symbol on the product or on its packaging indicates that this product may not be treated as household waste. Instead, it must be handed over to the appropriate waste collection centre for the recycling of electrical and electronic equipment.

By ensuring this product is disposed of correctly, you will help prevent potential negative consequences for the environment and human health, which could otherwise be caused by inappropriate waste handling of this product. For more detailed information about recycling of this product, please contact your local council office, your household waste disposal service or the shop where you purchased the product.

TECHNICAL SPECIFICATIONS

The manufacturer reserves the right to make changes to the technical specifications of the product

Nominal Voltage - Power Rating - Power Supply	See label on the inside of the service door
Housing material	Thermoplastic material
Size (w x h x d)	215 x 330 x 429 mm
Weight	7.5 kg
Power cord length	800 - 1200 mm
Control panel	Front panel
Cup sizes	Up to 152 mm
Water Tank	1.8 litres - Removable type
Coffee bean hopper capacity	250 g
Coffee grounds drawer capacity	15
Pump pressure	15 bar
Boiler	Stainless steel type
Safety devices	Thermal fuse

WARRANTY AND SERVICE

Warranty

For detailed information on your warranty and related conditions, please read the warranty booklet by-packed separately.

Service

We want to ensure that you remain satisfied with your machine. If you have not already done so, please register your purchase at **www.philips.com/welcome**. This will enable us to stay in contact with you and send you cleaning and descaling reminders.

If you need service or support, please visit the Philips website at **www.philips.com/support** or contact the Philips Saeco hotline in your country. The contact details can be found in the warranty booklet by-packed separately or on **www.philips.com/support**.

ORDERING MAINTENANCE PRODUCTS

For cleaning and descaling, use Saeco maintenance products only. You can purchase the products at the Philips online shop (if available in your country) at www.shop.philips.com/service, from your local dealer or authorised service centres.

If you have any difficulties obtaining maintenance products for your machine, please contact the Philips Saeco hotline in your country. The contact details can be found in the warranty booklet by-packed separately or on www.philips.com/support.

Overview of maintenance products:



- Descaling solution CA6700



- INTENZA+ Water filter cartridge CA6702

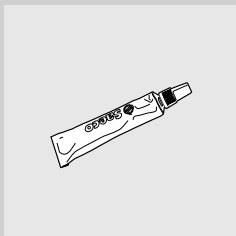

- Grease HD5061



- Coffee Oil Remover CA6704

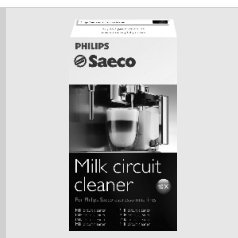

- Milk Circuit Cleaner: CA6705



- Maintenance Kit CA 6706



The manufacturer reserves the right to make changes without prior notice.

www.philips.com/welcome



421940438871

Rev.00 del 30-05-13